

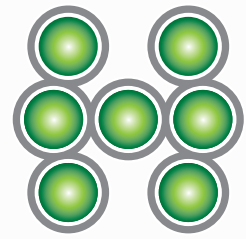

CATALOGO - CATALOGUE



MICROHARD[®]
VENDING PROJECTS



MADE IN ITALY

INDICE - INDEX



Attivatori portali self - Rollover activators.....

.....08



Attivatori piste self - Jet wash activators ..

.....16



Cambiamonete e cambiagettoni - Change machines..

.....20



Programma di fidelizzazione - Customers loyalty program

Letture targa - Car plate recognition24

Cashless fidelity PK4™26

Paymonitoring - Remote Control.....28

Periferiche - Payment System.....30

Sistemi di pagamento e accessori - Payment solutions and accessories.....33

Assistenza - Assistance.....34



TECNOLOGIE DI ATTIVAZIONE E SOLUZIONI PER AUTOLAVAGGI

**SMART
MACHINES**
INDUSTRY 4.0
COMPLIANT

Conformi ai requisiti tecnici
richiesti dall'industria 4.0 per
accedere agli incentivi fiscali.

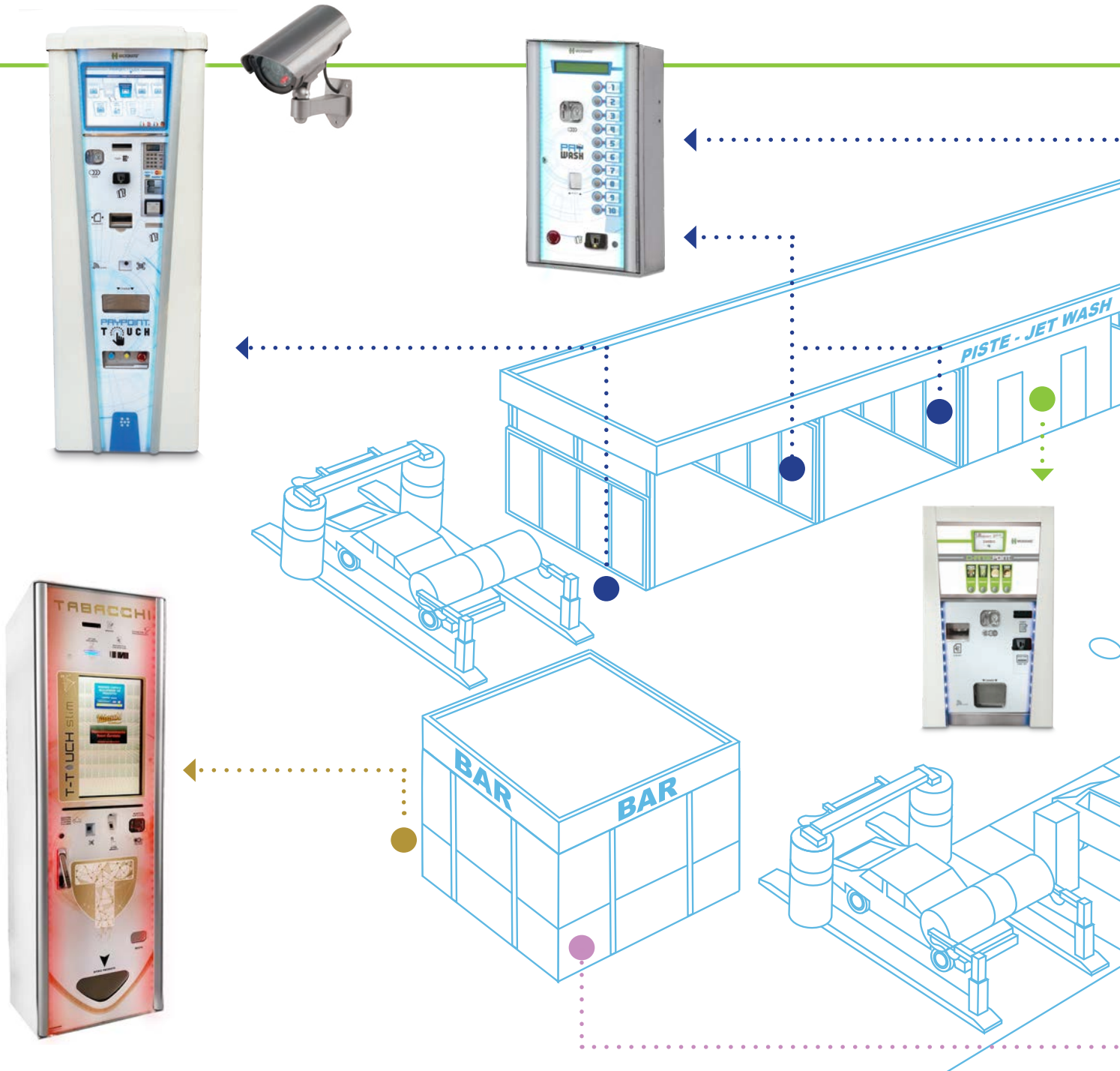

TECHNOLOGIES OF ACTIVATION AND SOLUTIONS FOR CARWASH

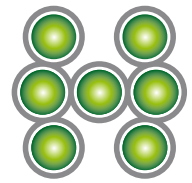

MICROHARD[®]
VENDING PROJECTS

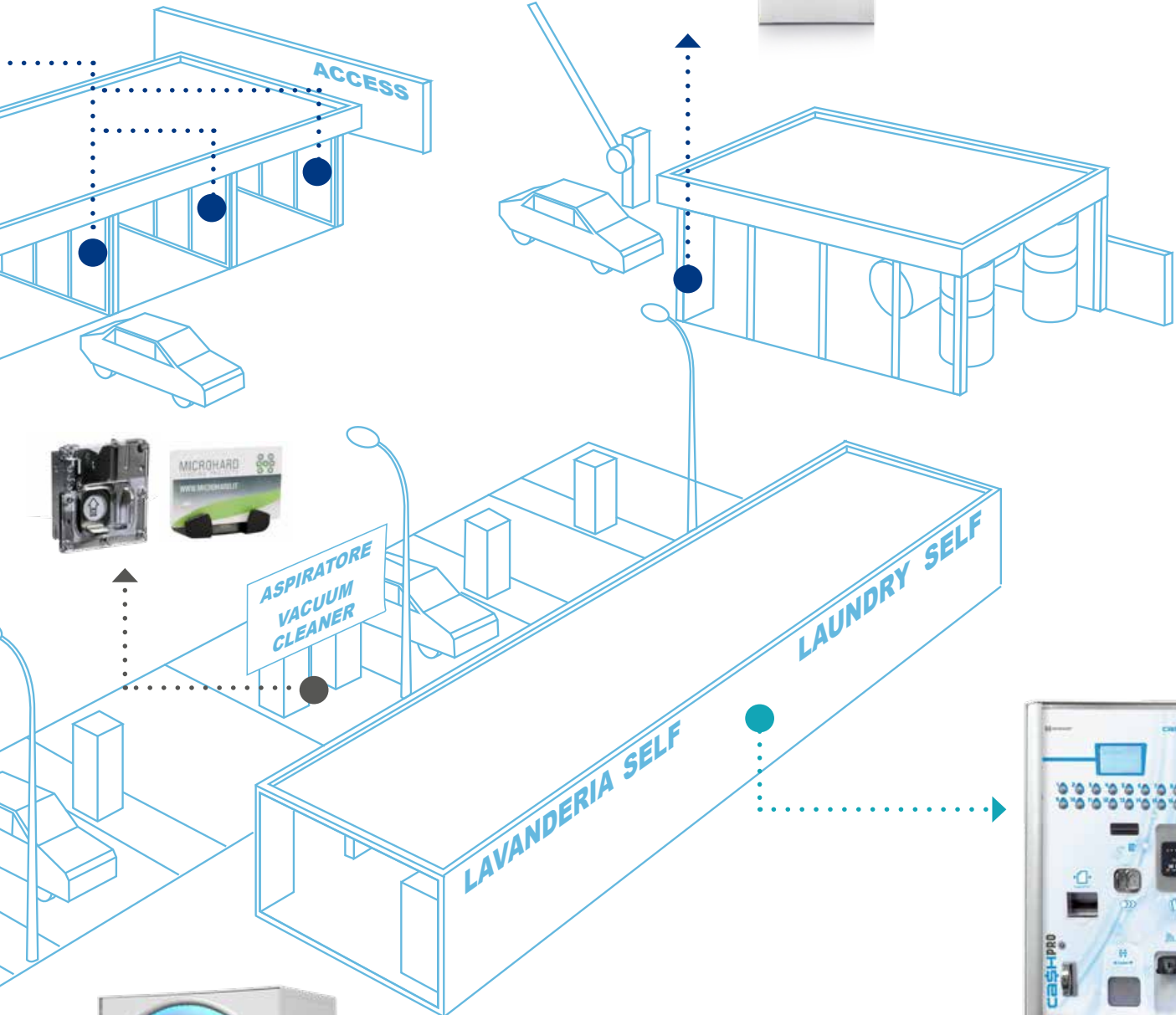



MICROHARD®, nata nel **1983** come studio di progettazione e realizzazione di sistemi di elettronica industriale e software, si è subito distinta con un ruolo di primaria importanza nello sviluppo di software riscontrando un notevole successo su tutto il territorio nazionale. All'inizio degli anni '90, mettendo a frutto l'esperienza maturata dai progettisti interni, ha esteso il suo mercato ai settori industriali e consumer.

Nell'anno 2001, dopo un'attenta analisi di mercato, Microhard® fonda PAYKEY USA, negli Stati Uniti, operante nel settore del cashless system per il mercato del vending; il marchio si è posizionato al vertice del settore, consentendo a Microhard® di acquisire importanti commesse statali nel New Jersey, in Nevada e in South Carolina.

A partire dal 2012, l'azienda investe risorse ed energie nel carwash riscontrando subito grande successo con primarie compagnie petrolifere e i principali operatori del settore.

Microhard® ha le risorse, esperienza e competenze per soddisfare le tue esigenze. Dall'ideazione alla progettazione fino alla produzione completa ...da oltre 35 anni.

TECNOLOGIA

Esperienza e abilità hanno permesso l'introduzione di tecnologie per un controllo totale dei prodotti da remoto.

Nel caso dei recentissimi apparecchi per autolavaggi, è persino possibile monitorare attraverso il proprio smartphone utilizzando un'apposita applicazione.

Microhard® realizza internamente tutte le fasi per lo sviluppo di nuovi prodotti, dalla **progettazione alla produzione.**

DESIGN

Microhard si contraddistingue con prodotti di elevata finitura estetica, senza compromessi sulla qualità o sulle accortezze antivandaliche. Un design accattivante e un'illuminazione a LED che ne valorizza la scocca, conferiscono alla linea di prodotti Microhard uno stile dai tratti unici, e soprattutto non mancano di catturare l'attenzione del consumatore.

Le più grandi aziende leader in produzione di elettrodomestici, nella farmaceutica e nella distribuzione di tabacchi e autolavaggi, hanno scelto Microhard per produrre intere gamme di distributori, casse automatiche o sistemi di pagamento.

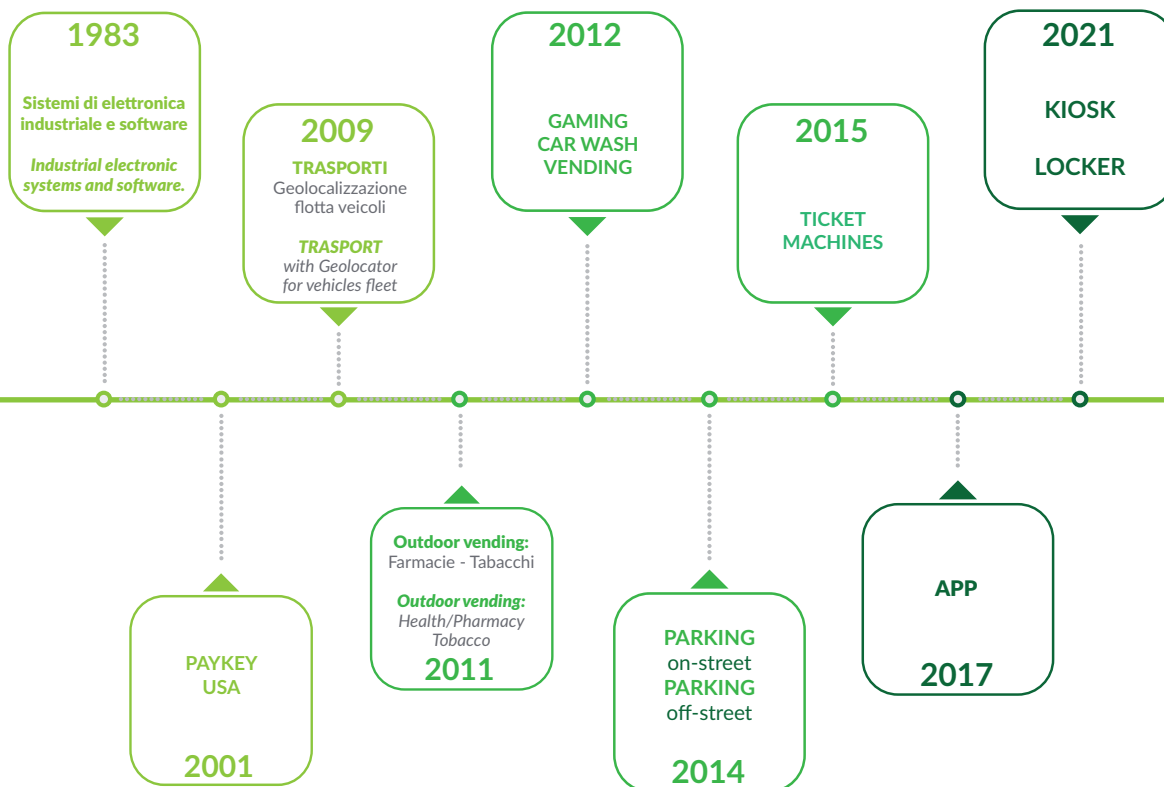

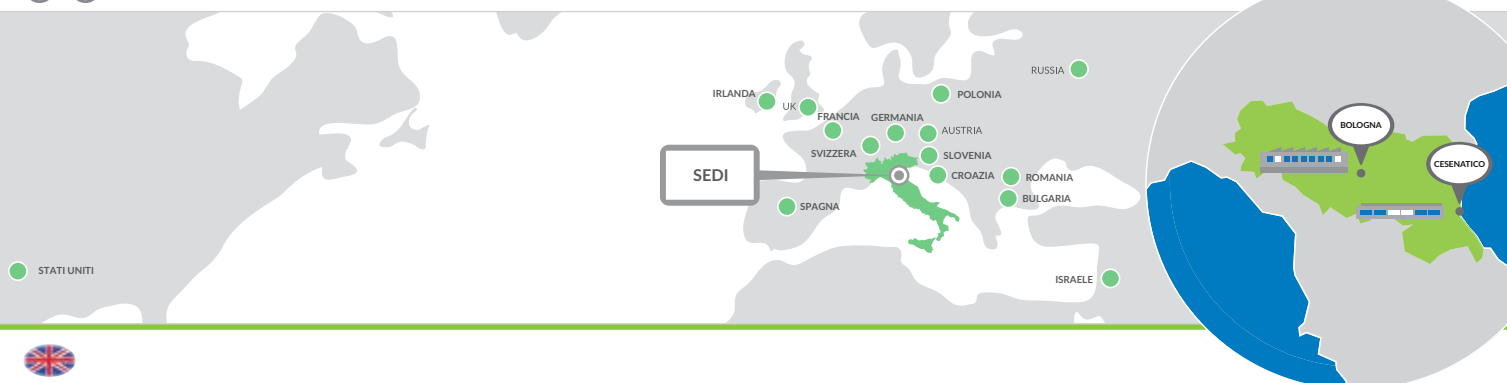

MICROHARD®, was founded in **1983** as a company to design and manufacture industrial electronic systems and software. Playing immediately a leading role in the software's development, achieves considerable success throughout the Italian country. At the beginning of the nineties, exploiting the experience reached by its designers, it extends operations to the industrial and consumer markets.

In 2001, following a painstaking market analysis, Microhard™ founded PAYKEY USA a new American company operating in the cashless system sector for the vending market. At the top of the sector, Microhard™ acquires important public tenders in New Jersey, Nevada and South Carolina.

Starting from 2012 the company invested resources and energy in the carwash field finding immediately great approval from the main oil companies and the most important workers in the sector.

Microhard® has the resources, experience and expertise to deliver your requirements. From concept through design to full production... we've been delivering peace of mind for over 35 years.

TECHNOLOGY

The company's experience and skills led it to introduce total remote product control technologies.

It is even possible to monitor the latest car wash equipment, using a smartphone featuring a special application.

Microhard® realizes internally all the stages for develop a new product, from design to production.

DESIGN

Microhard stands out for the attractive look of its products that do not compromise on quality or anti-vandal levels. An appealing design and a LED illumination that adds value to the frame, gives the Microhard product line a unique style and, especially, does not fail to capture the attention of consumers.

The leading companies in the production of electrical appliances, in pharmaceutical, tobacco and carwash field have chosen Microhard to produce a wide range of vending machines, automatic cash-machines or payment systems.

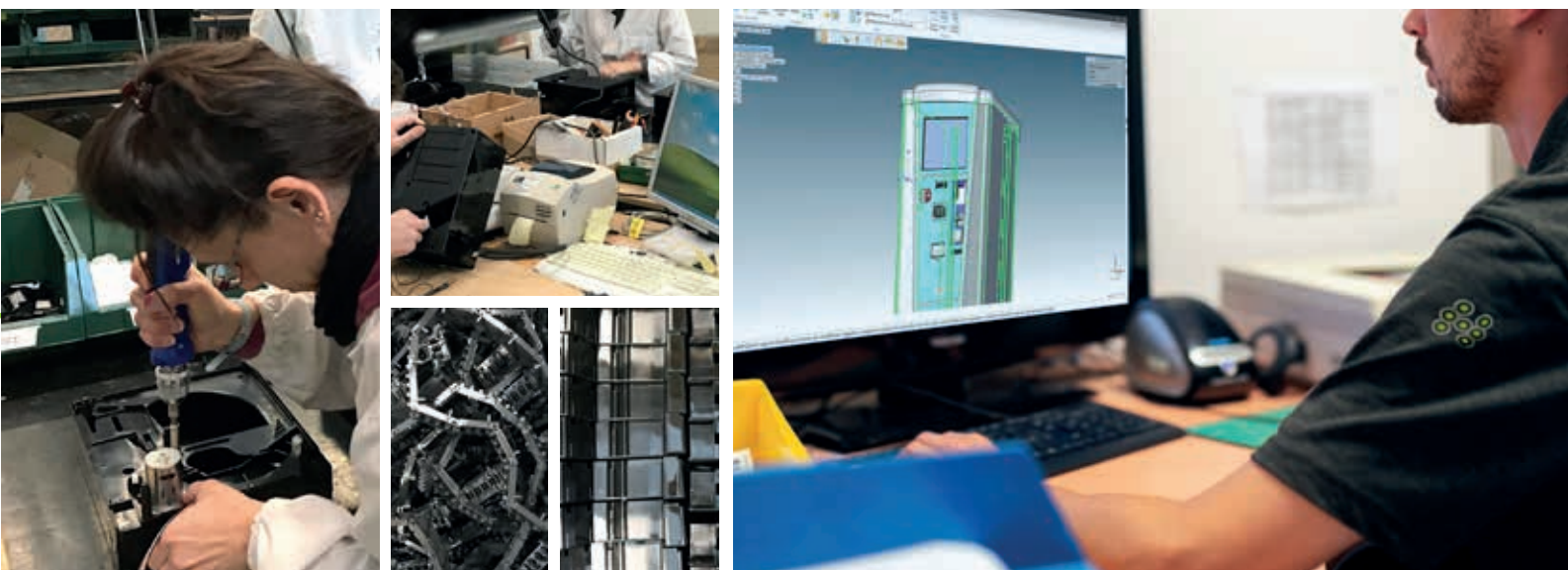

ATTIVATORE PER PORTALI SELF



ROLLOVER ACTIVATOR

La grafica intuitiva sullo schermo touch guida facilmente l'utente nella selezione delle varie funzioni e nell'attivazione del lavaggio.

The intuitive graphics on the touch monitor leads the user to select easily the different functions and the activation of the required washing program.



CAR PLATE RECOGNITION



- A** Sottomenù per proposte commerciali e marketing
 - B** Possibilità di inserire video personalizzati e pubblicitari
 - C** Telecamera lettura targhe per abbonamenti e massima flessibilità piani tariffari (vedi pag. 24)
- A Submenu to create commercial and marketing offers*
B Possibility of uploading personalized video and custom advertising
C Web cam for car plate recognition for subscribers and flexibility to apply rates plans for loyal clients (see page 24)

PAYPOINT TOUCH A PAVIMENTO

- Mobile inox verniciato
- Apertura posteriore
- Plexi frontale
- Monitor touch 15"
- 10 programmi,
- Cambio lingua
- Stampante
- 2 hopper (capacità 1.500 pz./cad)
- Cashless PK4
- Gettoniera elettronica tropicalizzata con inseritore antivandalico
- Lettore banconote con impacchettatore (200 banc) e protezione frontale
- Led RGB
- 3 pulsanti frontali (arresto, ripristino, riposiz)
- Modulo ethernet

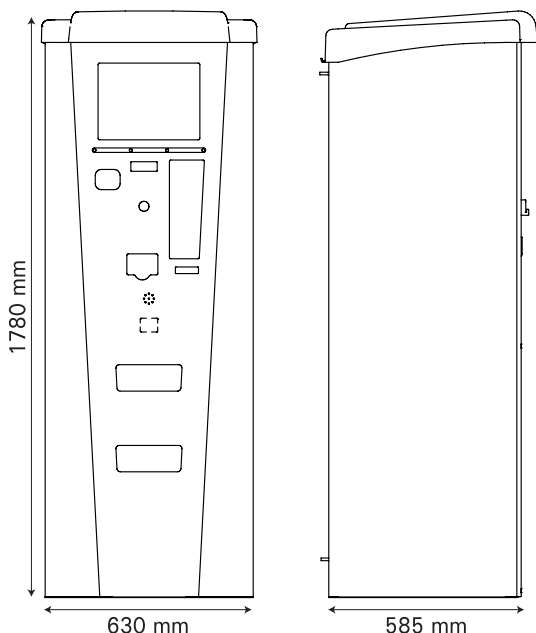

PAYPOINT TOUCH FREE STANDING

- Painted stainless steel
- Back opening,
- Front plexi
- Monitor touch 15"
- Up to 10 selections
- Language change
- Printer
- 2 hopper (capacity 1.500 pcs./each)
- Fidelity cashless PK4
- Tropicalized Electronic coin selector with vandal proof system
- Banknote acceptor with stacker (capacity 200pcs)
- RGB Led
- 3 frontal buttons (stop, reset, test)
- Ethernet connection



- Versione con 3 pulsanti laterali (arresto, ripristino, riposiz.)
- Plexi personalizzato
- App invio corrispettivi Agenzia delle Entrate

OPTIONAL*

- Kit Sensore di prossimità
- Kit Scaldiglia
- Kit card dispenser
- Kit card dispenser con codifica all'acquisto
- Kit Erogatore Tag con 100 blister (esclude 2° hopper)
- Kit Pos
- Kit sintesi vocale
- Kit sistema lettura targhe

* Optional e/o eventuali predisposizioni devono essere richiesti in fase di offerta e fornitura macchina

- Side 3 buttons version (stop, reset, test)
- Customized plexi

OPTIONAL*

- Kit Proximity sensor
- Kit Heater
- Kit Card dispenser
- Kit Card dispenser with encoder
- Kit Tag dispenser with 100 boxes (excluding 2° hopper)
- Kit Pos
- Kit Speech Synthesis
- Kit Camera car number plate recognition

* Optional and any predispositions must be requested during the offer and supply phase of the machine

**ATTIVATORE PER
PORTALI SELF**



**ROLLOVER
ACTIVATOR**



CARATTERISTICHE



PAYPOINT PRO A PAVIMENTO

- Mobile inox verniciato
- Apertura posteriore
- Plexi frontale
- Display grafico
- 8 programmi
- Cambio lingua
- 1 hopper (capacità 1.500 pz.)
- Cashless PK4,
- Gettoniera elettronica tropicalizzata con inseritore antivandalico
- Lettore banconote con impacchettatore (200 banc)
- Led RGB
- Modulo ethernet

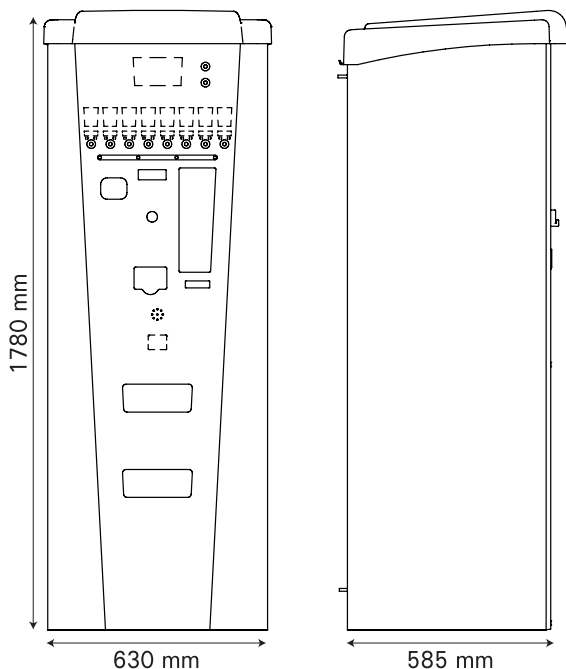

FEATURES



PAYPOINT PRO FREE STANDING

- Painted stainless steel
- Back opening
- Front plexi
- Graphic display
- Up to 8 selections
- Language change
- 1 hopper (capacity 1.500 pcs.)
- Fidelity cashless PK4
- Tropicalized Electroinc coin selector with vandal proof system
- Banknote acceptor with stacker (capacity 200pcs)
- RGB Led
- Ethernet connection



A RICHIESTA



- Plexi personalizzato
- App invio corrispettivi Agenzia delle Entrate

OPTIONAL*

- Kit 2° hopper (capacità 1.500 pz.)
- Kit stampante
- Kit Scaldiglia
- Kit card dispenser
- Kit Erogatore Tag con 100 blister (esclude 2°hopper)
- Kit Pos
- 3 pulsanti frontali (arresto, ripristino, riposiz); a richiesta laterali

ON REQUEST



- Customized plexi

OPTIONAL*

- Kit 2° hopper (capacity 1.500 pcs.)
- kit Printer
- Kit Heater
- Kit Card dispenser
- Kit Tag dispenser with 100 boxes (excluding 2° hopper)
- Kit Pos
- Kit 3 frontal buttons (stop, reset, test). On request fit on side

* Optional e/o eventuali predisposizioni devono essere richiesti in fase di offerta e fornitura macchina

* Optional and any predispositions must be requested during the offer and supply phase of the machine

**ATTIVATORE PER
PORTALI SELF**



**ROLLOVER
ACTIVATOR**



PAYPOINT DA INCASSO

- Mobile inox verniciato
- Apertura posteriore
- Display grafico
- 8 programmi
- Cambio lingua
- 1 hopper (capacità 1.500 pz.)
- Cashless PK4
- Gettoniera elettronica tropicalizzata con inseritore antivandalico
- Lettore banconote con impacchettatore (200 banc)
- Led RGB
- Modulo ethernet
- Staffe di fissaggio

PAYPOINT INTO THE WALL

- Painted (frame) stainless steel
- Back opening
- Front plexi
- Graphic display
- Up to 8 selections
- Language change
- 1 hopper (capacity 1.500 pcs.)
- Fidelity cashless PK4
- Tropicalized electroinc coin selector with vandal proof system
- Banknote Acceptor with stacker (capacity 200pcs)
- RGB Led
- Ethernet connection
- Mounting brackets

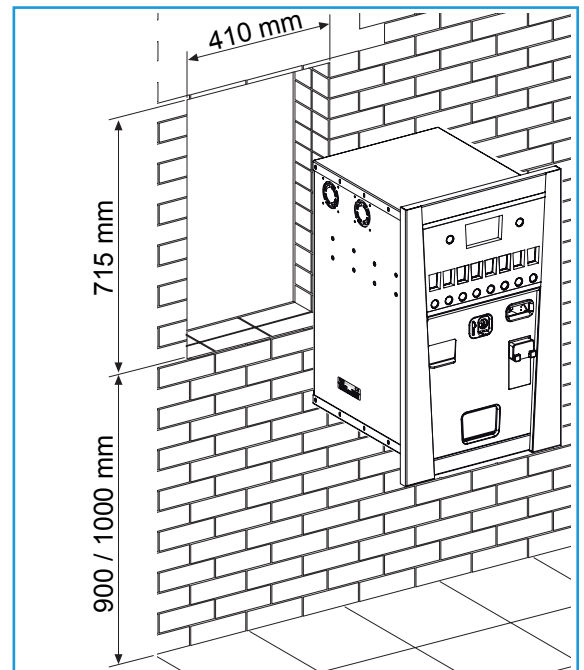
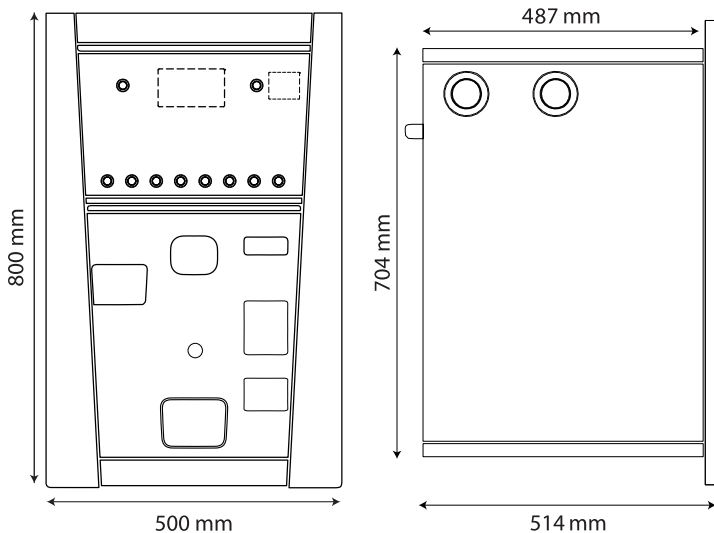

A RICHIESTA 

- Versione plexi personalizzato
- App invio corrispettivi Agenzia delle Entrate

OPTIONAL*

- Kit 2° hopper (capacità 1.500 pz.)
- kit stampante
- kit scaldiglia
- Kit card dispenser
- Kit Erogatore Tag con 100 blister (esclude 2° hopper)
- Kit Pos
- Kit 3 pulsanti frontali (arresto, ripristino,riposiz), fornito a parte non montato sulla macchina

ON REQUEST 

- Customized plexi

OPTIONAL*

- Kit 2° hopper (capacity 1.500 pcs.)
- kit Printer
- Kit Heater
- Kit Card dispenser
- Kit Tag dispenser with 100 boxes (excluding 2° hopper)
- Kit Pos
- Kit 3 buttons (stop, reset, test); supplied separately, not fixed on the machine

* Optional e/o eventuali predisposizioni devono essere richiesti in fase di offerta e fornitura macchina

* Optional and any predispositions must be requested during the offer and supply phase of the machine

PAYPOINT.mini

PAYPOINT.BASIC



ATTIVATORI PER
PORTALI SELF



*ROLLOVER
ACTIVATORS*



PAYPOINT.MINI



PAYPOINT.BASIC



PAYPOINT MINI and PAYPOINT BASIC

- Painted with epoxy resin for outdoor
- Front opening
- Front plexi (Paypoint.mini)
- Front adhesive (Paypoint.basic)
- Graphic display
- Up to 6 selections
- Language change
- Tropicalized Electroinc coin selector with vandal proof system
- Banknote acceptor with stacker (capacity 200pcs)
- White Led (Paypoint.mini)

PAYPOINT MINI e PAYPOINT BASIC

- Mobile verniciato per esterno
- Apertura anteriore
- Plexi frontale (Paypoint.mini)
- Adesivo frontale (Paypoint.basic)
- Display grafico
- 6 programmi
- Cambio lingua
- Gettoniera elettronica tropicalizzata con inseritore antivandalico
- Lettore banconote con impacchettatore (200 banc)
- Led bianchi (Paypoint.mini)

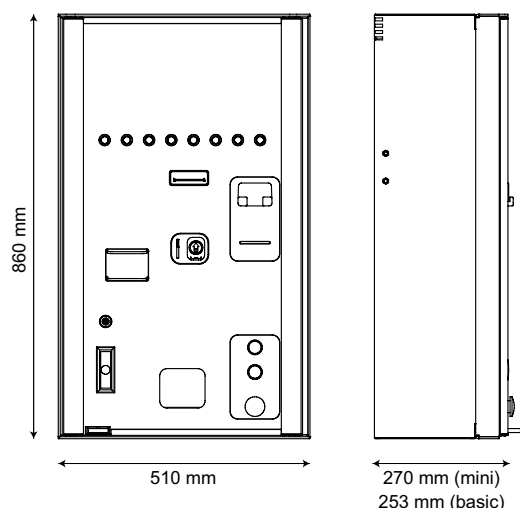

VERSIONI DISPONIBILI

- A** Fissaggio diretto a parete
- B** Incassato a muro (mediante kit staffe optional)
- C** Fissaggio a pavimento (mediante piedistallo optional)

AVAILABLE VERSIONS

- A** Direct fastening to the wall
- B** Build-in to the wall (through optional bracket kit)
- C** Fastening to the floor (through optional base)

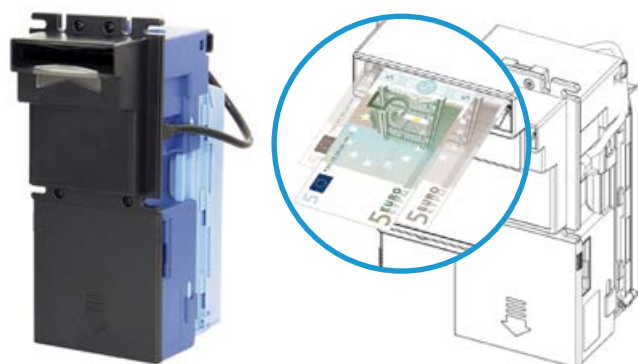
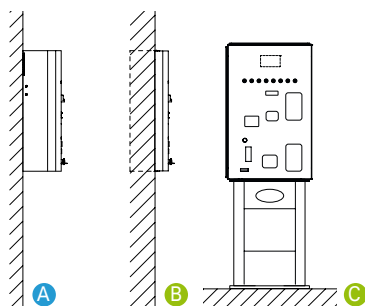

Impacchettatore (200 banc) stacker (200pcs)



Inseritore antivandalico Vandal proof system



A RICHIESTA 

- Versione inox
- Versione plexi personalizzato (Paypoint.mini)
- Versione adesivo personalizzato (Paypoint.basic)
- Versione Led RGB (Paypoint.mini)
- App invio corrispettivi Agenzia delle Entrate

OPTIONAL*

- Kit 1° hopper (capacità 1.500 pz.)
- Kit 2° hopper (capacità 1.500 pz.)
- kit stampante (esclude 2° hopper)
- kit scaldiglia
- Kit card dispenser
- Kit Pos
- Kit 3 pulsanti frontali (arresto, ripristino,riposiz)
- Kit cashless PK4
- Kit modulo ethernet
- Kit allarme
- Kit staffe fissaggio a incasso
- Kit piedistallo inox verniciato, con sportello anteriore e predisposizione per i 3 pulsanti. Inclusa schiena protez. macchina
- Kit schiena protez. macchina fornito a parte

* Optional e/o eventuali predisposizioni devono essere richiesti in fase di offerta e fornitura macchina

ON REQUEST 

- Stainless steel version
- Customized plexi (Paypoint.mini)
- Customized adhesive (Paypoint.basic)
- RGB Led(Paypoint.mini)

OPTIONAL*

- Kit 1° hopper (capacity 1.500 pcs.)
- Kit 2° hopper (capacity 1.500 pcs.)
- kit Printer (excluding 2° hopper)
- Kit Heater
- Kit Card dispenser
- Kit Pos
- Kit 3 frontal buttons (stop, reset, test)
- Kit Fidelity cashless PK4
- Kit Ethernet connection
- Kit Alarm
- Kit Mounting brackets to fix into the wall
- Kit Floor column/pedestal painted stainless steel with frontal opening; predisposition for 3 buttons. Back cover for the machine included
- Kit Back cover for the machine (supplied separately)

* Optional and any predispositions must be requested during the offer and supply phase of the machine

ATTIVATORE PER PISTE SELF



JET WASH ACTIVATOR



**COLLEGAMENTO
ETHERNET
ETHERNET
CONNECTION**



**REMOTE
CONTROL**



**10 Programmi
Fissaggio a parete**

*10 selections
Direct fastening to
the wall*



**10 Programmi
Incasso a muro**

*10 selections
Build-in to the wall*



**10 Programmi
Colonna**

*10 selections
Fastening to
the floor*

PAYWASH

- Mobile inox
- Apertura anteriore
- Plexi frontale
- Display alfanumerico
- 10 programmi
- Legenda programmi
- Cambio lingua
- Gettoniera elettronica tropicalizzata con inseritore antivandalico
- Pulsante emergenza
- buzzer
- Led bianchi
- Modulo Ethernet
- Staffe di fissaggio (PayWash incasso)

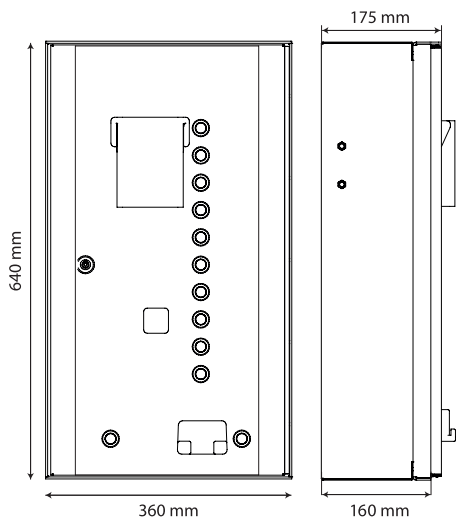

VERSIONI DISPONIBILI

- A** Fissaggio diretto a parete
- B** Incassato a muro
- C** Fissaggio a pavimento (mediante piedistallo optional)

AVAILABLE VERSIONS

- A** Direct fastening to the wall
- B** Build-in to the wall
- C** Fastening to the floor (through optional base)

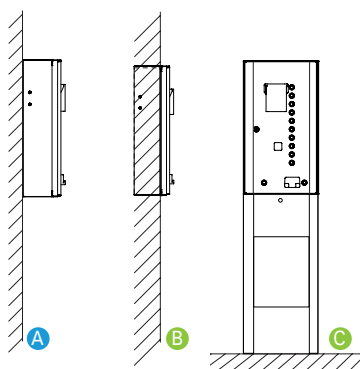

PAYWASH

- *Stainless steel*
- *Front opening*
- *Front plexi*
- *Alphanumeric display*
- *Up to 10 selections*
- *Programs legend*
- *Language change*
- *Tropicalized electroinc coin selector with vandal proof system*
- *Stop button*
- *Buzzer*
- *White Led*
- *Ethernet connection*
- *Mounting brackets (PayWash wall mounted)*

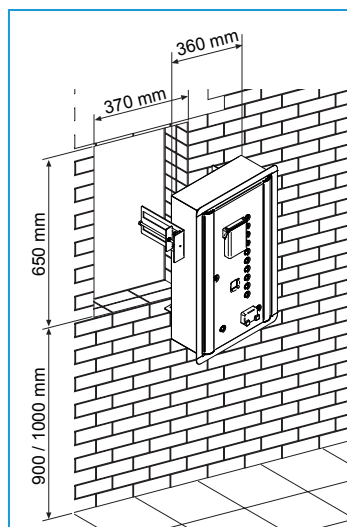
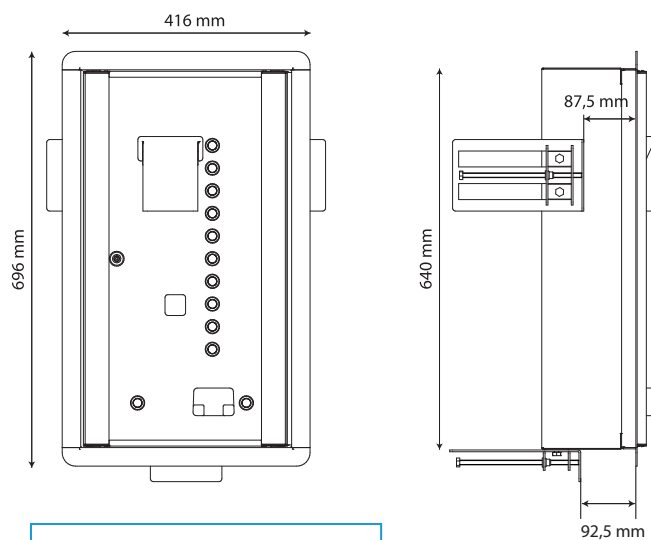

A RICHIESTA 

- Versione inox verniciato
- Versione con sistema a goccia basculante protezione gettoniera
- Versione plexi personalizzato
- Piedistallo versione inox verniciato (PayWash Colonna)
- App invio corrispettivi Agenzia delle Entrate

OPTIONAL*

- Kit cashless PK4, incluso pulsante di credito
- Kit piedistallo incluso schiena
- Kit schiena fornito a parte
- Kit sportellino protezione gettoniera
- Kit lettore di banconote e sportellino per piedistallo

* Optional e/o eventuali predisposizioni devono essere richiesti in fase di offerta e fornitura macchina

ON REQUEST 

- *Painted stainless steel version*
- *Version with tilting cover for coin selector*
- *Customized plexi*
- *Painted floor column/pedestal stainless steel (PayWash column)*

OPTIONAL*

- *Kit Fidelity cashless PK4, credit button included*
- *Kit Floor column/pedestal. Back cover for the machine included*
- *Kit Back cover for the machine (supplied separately)*
- *Kit coin selector cover over vandal proof system*
- *Kit banknote reader with cover, for column/pedestal*

* Optional and any predispositions must be requested during the offer and supply phase of the machine

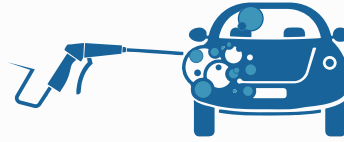

7 Programmi
Fissaggio a parete

7 selections
Direct fastening to
the wall

7 Programmi
Colonna

7 selections
Fastening to
the floor

7 Programmi
Incasso a muro

7 selections
Build-in to the wall



SENZA COLLEGAMENTO ETHERNET
WITHOUT ETHERNET CONNECTION



PAYWASH BASIC

- Mobile inox
- Apertura anteriore
- Plexi frontale
- Display alfanumerico
- 7 programmi
- Cambio lingua
- Gettoniera elettronica tropicalizzata con inseritore antivandalico
- Staffe di fissaggio (PayWash incasso)

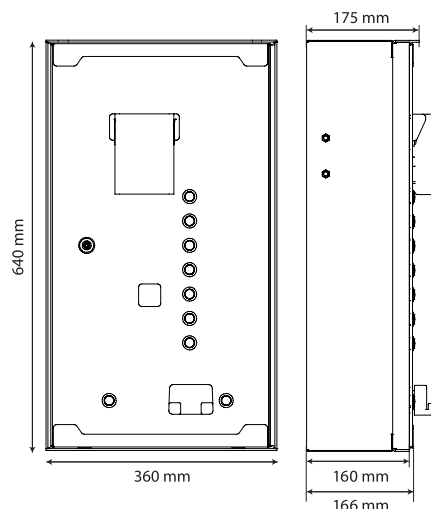

PAYWASH BASIC

- *Stainless steel*
- *Front opening*
- *Front plexi*
- *Alphanumeric display*
- *Up to 7 selections*
- *Language change*
- *Tropicalized electronic coin selector with vandal proof system*
- *Mounting brackets (PayWash wall mounted)*

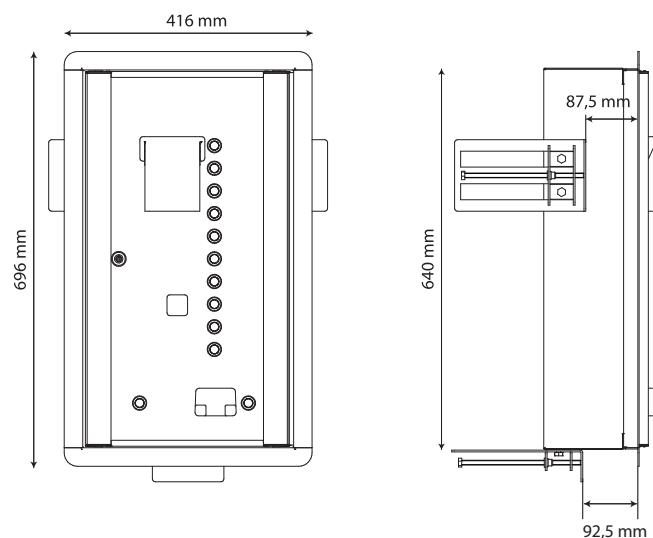

VERSIONI DISPONIBILI

- A** Fissaggio diretto a parete
- B** Incassato a muro
- C** Fissaggio a pavimento (mediante piedistallo optional)

AVAILABLE VERSIONS

- A** Direct fastening to the wall
- B** Build-in to the wall
- C** Fastening to the floor (through optional base)

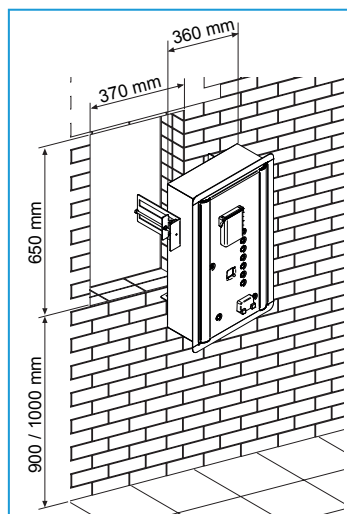
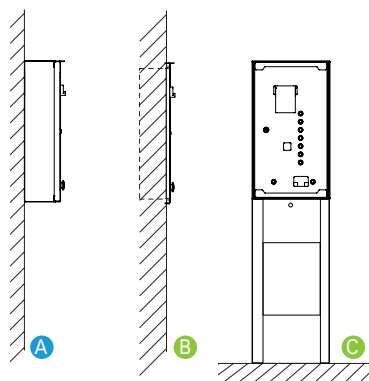

A RICHIESTA



- Versione inox verniciato
- Versione con sistema a goccia basculante protezione gettoniera
- Versione plexi personalizzato
- Piedistallo versione inox verniciato (PayWash Colonna)
- App invio corrispettivi Agenzia delle Entrate

OPTIONAL*

- Kit cashless PK4 + Display, incluso pulsante di credito
- Kit piedistallo incluso schiena
- Kit schiena fornito a parte
- kit pulsante emergenza
- Kit led bianchi
- Kit sportellino protezione gettoniera

* Optional e/o eventuali predisposizioni devono essere richiesti in fase di offerta e fornitura macchina

ON REQUEST



- *Painted stainless steel version*
- *Version with tilting cover for coin selector*
- *Customized plexi*
- *Painted floor column/pedestal stainless steel (PayWash column)*

OPTIONAL*

- *Kit Fidelity cashless PK4 + Display, credit button included*
- *Kit Floor column/pedestal.*
- *Back cover for the machine included*
- *Kit Back cover for the machine (supplied separately)*
- *kit Stop button*
- *Kit White Led*
- *Kit coin selector cover over vandal proof system*

* Optional and any predispositions must be requested during the offer and supply phase of the machine

CHANGEPOINT. PRO CHANGEPOINT.

CAMBIAMONETE E
CAMBIA GETTONI



CHANGE
MACHINES



CHANGEPOINT.
4 programmi
Incasso a muro

*4 selections
Build-in to the wall*



CHANGEPOINT.PRO
4 programmi
Colonna

*4 selections
Fastening to
the floor*

CHANGEPOINT PRO e CHANGEPOINT

- Mobile inox verniciato
- Apertura posteriore
- Plexi frontale
- Display grafico
- Cambio lingua
- 4 programmi di cambio
- 2 hopper (cad/1.500 pz.)
- Cashless PK4
- Gettoniera elettronica tropicalizzata con inseritore antivandalico
- Lettore banconote con impacchettatore (200 banconote)
- Led RGB
- Modulo ethernet
- Staffe di fissaggio (ChangePoint da incasso)

CHANGEPOINT.PRO

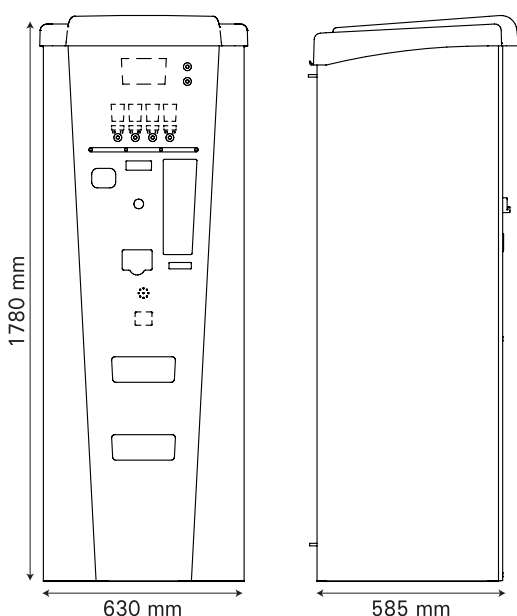

CHANGEPOINT PRO and CHANGEPOINT

- Painted stainless steel
- Back opening
- Front plexi
- Graphic display
- Language change
- 4 programming/function buttons
- 2 hopper (each/1.500 pcs.)
- Fidelity cashless PK4
- Tropicalized electroinc coin selector with vandal proof system
- Banknote Acceptor with stacker (capacity 200pcs)
- RGB Led
- Ethernet connection
- Mounting brackets (ChangePoint wall mounted)

CHANGEPOINT.

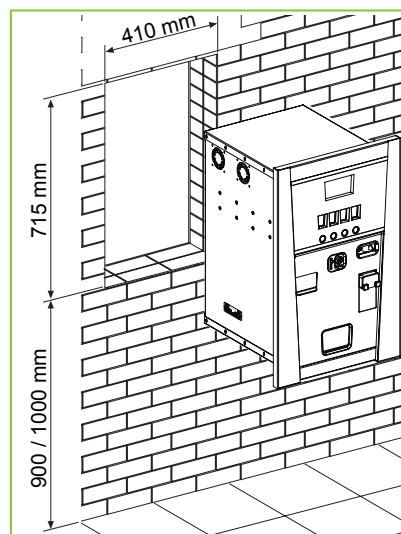
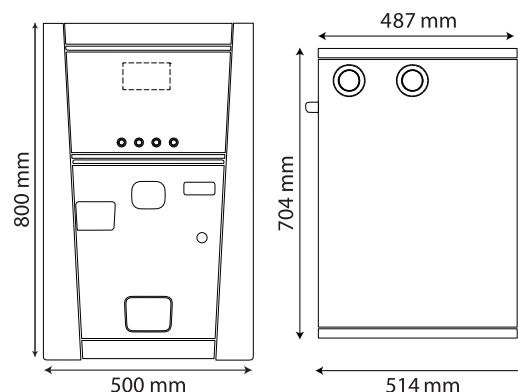

- Versione plexi personalizzato
- App invio corrispettivi Agenzia delle Entrate

OPTIONAL*

- Kit stampante
- Kit scaldiglia
- Kit card dispenser
- Kit Erogatore Tag con 100 blister (esclude 2° hopper)
- Kit pos per acquisto gettoni

* Optional e/o eventuali predisposizioni devono essere richiesti in fase di offerta e fornitura macchina

- Customized plexi

OPTIONAL*

- Kit Printer
- Kit Heater
- Kit Card dispenser
- Kit Tag dispenser with 100 boxes (excluding 2° hopper)
- Pos kit for buying tokens

* Optional and any predispositions must be requested during the offer and supply phase of the machine

CHANGE.mini CHANGE.BASIC

**CAMBIAMONETE E
CAMBIA GETTONI**



**CHANGE
MACHINES**



CHANGE.MINI



CHANGE.BASIC



CHANGE MINI e CHANGE BASIC

- Mobile verniciato per esterno
- Apertura anteriore
- Plexi frontale (Change Mini)
- Adesivo frontale (Change Basic)
- Display grafico
- Cambio lingua
- 1 hopper (capacità 1.500 pz.)
- Gettoniera elettronica tropicalizzata con inseritore antivandalo
- Lettore banconote con impacchettatore (200 banc)
- Led bianchi (Change Mini)

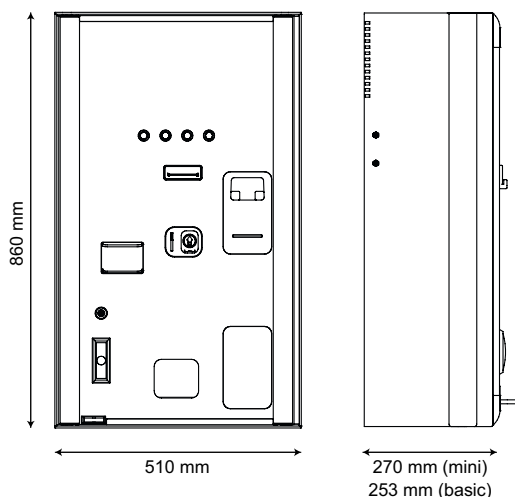

VERSIONI DISPONIBILI

- A** Fissaggio diretto a parete
- B** Incassato a muro (mediante kit staffe optional)
- C** Fissaggio a pavimento (mediante piedistallo optional)

AVAILABLE VERSIONS

- A** Direct fastening to the wall
- B** Build-in to the wall (through optional bracket kit)
- C** Fastening to the floor (through optional base)

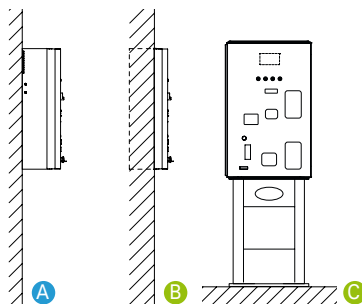

CHANGE MINI and CHANGE BASIC

- Painted with epoxy resin for outdoor
- Front opening
- Front plexi (Change Mini)
- Front adhesive (Change Basic)
- Graphic display
- Language change
- 1 hopper (capacity 1.500 pcs.)
- Tropicalized electronic coin selector with vandal proof system
- Banknote Acceptor with stacker (capacity 200pcs)
- White Led (Change Mini)

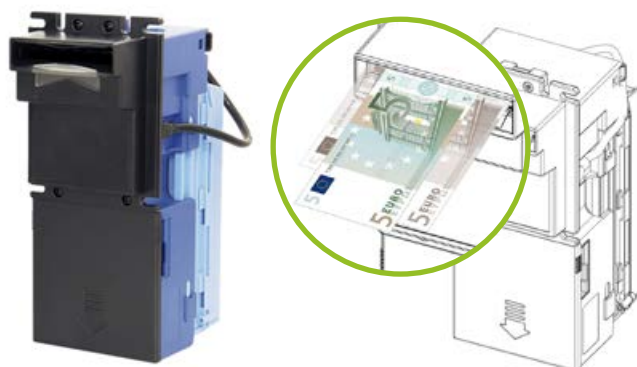

Impacchettatore (200 banc) stacker (200pcs)



Inseritore antivandalo Vandal proof system



A RICHIESTA



- Versione inox
- Versione plexi personalizzato (Change Mini)
- Versione Led RGB (Change Mini)
- Versione adesivo personalizzato (Change Basic)
- App invio corrispettivi Agenzia delle Entrate

OPTIONAL*

- Kit 2° hopper (capacità 1.500 pz.)
- kit stampante (esclude 2° hopper)
- kit scaldiglia
- Kit card dispenser
- Kit pos per acquisto gettoni
- Kit cashless PK4
- Kit modulo ethernet
- Kit allarme
- Kit staffe fissaggio a incasso
- Kit piedistallo inox verniciato, con sportello anteriore. Inclusa schiena protez. macchina
- Kit schiena protez. macchina fornito a parte

ON REQUEST



- Stainless steel version
- Customized plexi (Change Mini)
- RGB Led (Change Mini)
- Customized plexi (Change Basic)

OPTIONAL*

- Kit 2° hopper (capacity 1.500 pcs.)
- kit Printer (excluding 2° hopper)
- kit Heater
- Kit Card dispenser
- Pos kit for buying tokens
- Kit Fidelity cashless PK4
- Kit Ethernet connection
- Kit Alarm
- Kit Mounting brackets to fix into the wall
- Kit Floor column/pedestal painted stainless steel with frontal opening. Back cover for the machine included
- Kit Back cover for the machine (supplied separately)

* Optional e/o eventuali predisposizioni devono essere richiesti in fase di offerta e fornitura macchina

* Optional and any predispositions must be requested during the offer and supply phase of the machine



PROGRAMMA DI FIDELIZZAZIONE PER IL CLIENTE

TELECAMERA LETTURA TARGHE



CUSTOMERS LOYALTY PROGRAM

CAR PLATE RECOGNITION system

**Availability may differ by Country*



CAR PLATE RECOGNITION

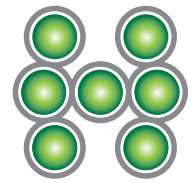

MICROHARD[®]
VENDING PROJECTS

Car Plate Recognition by Microhard



Il sistema Car Plate Recognition è destinato all' utilizzo congiunto con la soluzione Paypoint Touch per i lavaggi automatici dei veicoli al fine di introdurre nuove funzionalità e flessibilità grazie alla capacità di lettura della targa del veicolo.

La logica è stata organizzata per poter attuare politiche di lavaggio:

- in ausilio alle funzionalità della Paypoint Touch
- per abbonamenti prepagati
- per abbonamenti su base temporale
- per abbonamenti a carnet di un certo numero di lavaggi

Nello specifico le funzionalità implementate offrono:

1. La possibilità di attuazione delle politiche di tariffazione del lavaggio su singolo utente (inteso quale targa del veicolo) e su gruppi di utenti.
2. La possibilità di gestione di un plafond pre-pagato con soglia sul singolo veicolo e sul gruppo.
3. La possibilità di ricarica del plafond di veicolo e del gruppo attraverso l' accettatore del Paypoint Touch.
4. La possibilità di uno sconto pre-impostato sul singolo veicolo e sul gruppo.
5. La possibilità di vincolare l' abbonamento, sul singolo veicolo e sul gruppo, ad un periodo temporale
6. La possibilità di vincolare l' abbonamento, sul singolo veicolo e sul gruppo, ad un numero di lavaggi.
7. La possibilità di vincolare l' abbonamento, sul singolo veicolo e sul gruppo ad una specifica tipologia di lavaggio.
8. La possibilità di esecuzione di un lavaggio con pagamento diretto attraverso la Paypoint Touch anche per veicoli abbonati.
9. La possibilità di introduzione di un periodo di inibizione al fine di evitare lavaggi in abbonamento ravvicinati.
10. Una comunicazione "precoce" con la Paypoint Touch al fine di visualizzare sull' interfaccia della macchina stessa le possibilità di lavaggio compresa quella in abbonamento.
11. La possibilità di notifica email all' utente, del veicolo e del gruppo, dell' esecuzione di un lavaggio.
12. La possibilità di notifica email all' utente, del veicolo e del gruppo, della mancata esecuzione di un lavaggio dopo un periodo pre-definibile.
13. La possibilità di notifica email all' amministratore, dell' esecuzione di un lavaggio da parte di un utente indesiderato.



The Car Plate Recognition system is designed to be used in combination with the Paypoint Touch Payment Solution , for automatic carwash roll over destined to vehicles, with the target of introducing new functions and more flexibility through the plate recognition access.

The logic has been organized to be able to implement different washing policies:

- as support to the functions of the Pay point Touch
- for prepaid subscription
- for subscription on a time basis
- for subscription upon a carnet of fixed numbers of washing

The functions implemented offer:

1. The possibility to activate different washing pricing policies for a single client (identified with the car plate number) or for a group of clients
2. The possibility to manage a pre-paid plafond with the threshold of a single vehicle or group
3. The possibility of recharging the plafond of a single vehicle or of the group through the Paypoint Touch acceptor
4. The possibility of setting a discount on a single vehicle or on a group
5. The possibility of binding for a fixed period the subscription of a single vehicle or of a group
6. The possibility of binding to a fixed numbers of washing the subscription of a single vehicle or of a group
7. The possibility of binding to a fixed washing program the subscription of a single vehicle or of a group
8. The possibility of executing a washing program by direct payment through the Paypoint Touch also for subscribed vehicles
9. The possibility of introducing a period of inhibition to avoid close washings upon subscription
10. A "early "communication with the Paypoint Touch, allows to view on the machine interface the various options of washing programs , including the ones under subscription
11. The possibility for the end user of getting a notice by email, regarding the vehicle or group of vehicles after the execution of a washing program
12. The possibility for the end user of getting a notice by email, regarding the vehicle or group of vehicles after a missing execution of a washing program after a pre- defined period
13. The possibility for the administrator to get a notice by email after an execution of a washing program from an undesired end user

STORICO LAVAGGI				
Numero	Descrizione	Data Lavaggio	Data Abbon.	Data Fine
100001	1. Standard	2023-10-26 10:15	2023-10-26	2023-10-26
100002	2. Standard	2023-10-26 10:30	2023-10-26	2023-10-26
100003	3. Standard	2023-10-26 10:45	2023-10-26	2023-10-26
100004	4. Standard	2023-10-26 11:00	2023-10-26	2023-10-26
100005	5. Standard	2023-10-26 11:15	2023-10-26	2023-10-26
100006	6. Standard	2023-10-26 11:30	2023-10-26	2023-10-26
100007	7. Standard	2023-10-26 11:45	2023-10-26	2023-10-26
100008	8. Standard	2023-10-26 12:00	2023-10-26	2023-10-26
100009	9. Standard	2023-10-26 12:15	2023-10-26	2023-10-26
100010	10. Standard	2023-10-26 12:30	2023-10-26	2023-10-26
100011	11. Standard	2023-10-26 12:45	2023-10-26	2023-10-26
100012	12. Standard	2023-10-26 13:00	2023-10-26	2023-10-26
100013	13. Standard	2023-10-26 13:15	2023-10-26	2023-10-26
100014	14. Standard	2023-10-26 13:30	2023-10-26	2023-10-26
100015	15. Standard	2023-10-26 13:45	2023-10-26	2023-10-26
100016	16. Standard	2023-10-26 14:00	2023-10-26	2023-10-26
100017	17. Standard	2023-10-26 14:15	2023-10-26	2023-10-26
100018	18. Standard	2023-10-26 14:30	2023-10-26	2023-10-26
100019	19. Standard	2023-10-26 14:45	2023-10-26	2023-10-26
100020	20. Standard	2023-10-26 15:00	2023-10-26	2023-10-26

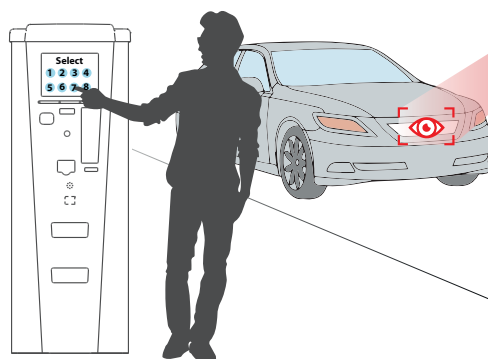



PROGRAMMA DI FIDELIZZAZIONE PER IL CLIENTE

CASHLESS FIDELITY PK4™



* CARD PK4 con possibilità di
PERSONALIZZAZIONE GRAFICA

* PK4 CARD with possibility to get
CUSTOM GRAPHIC

Come tu mi vuoi - As you want



* A RICHIESTA - ON REQUEST



CUSTOMERS LOYALTY PROGRAM

CASHLESS FIDELITY PK4™

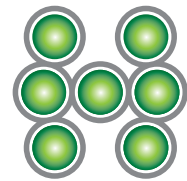

MICROHARD[®]
VENDING PROJECTS

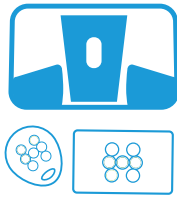

CASHLESS FIDELITY PK3™



Cashless fidelity PK4™ by Microhard



Cashless Fidelity PK4: il sistema Cashless che incrementa le vendite dal 20% al 40%

Il sistema Cashless più semplice da installare, più flessibile e performante per caratteristiche funzionali ed estetiche, è il PK4 Microhard. Compatto, progettato e costruito per applicazioni in esterno ha un' elettronica predisposta per dialogare con ogni protocollo, e raggruppa il più alto numero di funzioni utilizzabili.

Un solo dispositivo di lettura per Tag o Card prepagate.

SISTEMA FIDELITY PK4 - CARATTERISTICHE

- Può essere applicato su portali, piste, aspiratori e lavatappeti
- Possibilità di gestire diverse formule di marketing
- Possibilità di applicare sconti ad ogni servizio pagato con tessera
- Free-Credit/Credito gratuito: il PK4 attribuisce alla tessera un credito con periodicità giornaliera, settimanale, quindicinale o mensile che può essere differenziato fino a 4 tipi diversi di tessera (4 livelli) permettendo così di dare cifre diverse a seconda del tipo di cliente.
- Free-Vend/Vendite gratuite: il PK4 attribuisce alla tessera l' erogazione gratuita del servizio con cadenza giornaliera, settimanale, quindicinale o mensile che può essere differenziata fino a 4 tipi diversi di tessera (4 livelli).
- Bonus di ricarica: credito aggiuntivo attribuito al raggiungimento di una certa cifra introdotta per ricaricare la tessera (applicabile a tutte le macchine Microhard tranne il modello PayWash)
- Sostituzione di una gettoniera parallela: il PK4 può sostituire una gettoniera e permette di utilizzare la tessera come se fosse un portamonete.

PK-TOOL

Letture e scrittore carte e tag comprensivo di Software per una completa gestione del tuo sistema cash less PK4.



Cashless Fidelity PK4: the Cashless system increases the sales from 20% to 40%

The Microhard PK4 is the easier Cashless system to set up, it is also more flexible and more performant due to its tech features and for its look. It is compact, designed and built for outdoor application, with an electronics set up to communicate with each protocol and that has the highest number of usable functions.

A unique reading device both for prepaid tags and cards.

PK4 FIDELITY SYSTEM - FEATURES

- It can be applied on roll-over, jet wash, aspirator and carpet wash
- It allows to manage different marketing offers
- It allows to apply discount at each service that is paid by card
- Free-Credit: the PK4 can assign a credit to the card with different options of frequency: daily, weekly, twice a week, or monthly. This assignment can be diversified till four types of different cards (4 levels), granting the possibility to give different credit value according to the type of client
- Free-Sales: the PK4 can assign a free of charge dispensing of service with different options of frequency: daily, weekly, twice a week, or monthly. This assignment can be diversified till four types of different cards (4 levels)
- Recharge Bonus: additional credit assigned when reached a prefixed target amount. The credit can be uploaded once the card is introduced to be recharge (this option is applicable on all Mh machines but Paywash models).
- Replacement of a parallel coin validator: the PK4 can replace a coin validator and allows the use of the card like a money bag

Cards and tags reader and writer including a software for a complete manage of your Cash less PK4 System.



Display PK4



A



B

Bocchetta e sistema PK4 fornito a parte.
Nozzle and PK4 system supplied aside.

PAYMONITORING

Sistema di rilevazione e reportistica per il car-wash

STATISTICHE: (incassi, venduto, ricariche, resto ecc..)

PROGRAMMI: per un'analisi dettagliata dei programmi più o meno usati e definire quindi le opportune strategie di marketing tramite PK4

LOGS: controllo dettagliato delle operazioni fatte dalla macchina

ALLARMI: ad esempio erogatore vuoto, stop emergenza

LINK AL METEO: per una maggiore analisi sull'andamento dei portali



Alcuni esempi di visualizzazioni / some examples of the visible activities

LOG RIASSUNTO DI TUTTE LE OPERAZIONI DELLA MACCHINA - SUMMARY OF ALL MACHINE OPERATIONS

Serial Number	Tipo	Prodotto	Descrizione	Descrizione	Tipo di pagamento	Data
60254	Ticket	0	Ticket ChangeFailed	0,00		2021-02-25 22:53:23
60254	Return	0	REST PROVIDED	0,00		2021-02-25 22:53:19
60254	Return	0	REST PROVIDED	0,00		2021-02-25 22:53:15
60254	CashIn	0	CASH ENTERED	10,00		2021-02-25 22:52:44
60254	Ticket	0	Ticket ChangeFailed	0,00		2021-02-25 20:38:20
60254	Return	0	REST PROVIDED	0,00		2021-02-25 20:38:16
60254	Return	0	REST PROVIDED	0,00		2021-02-25 20:38:12
60254	Program	34	Sync fgs	9,00	Cash	2021-02-25 20:37:38
60254	Ticket	0	PRINT REQUEST: OK!!	0,00		2021-02-25 20:37:19
60254	CashIn	0	CASH ENTERED	10,00		2021-02-25 20:37:11

PAYMONITORING *Availability may differ by Country

Auditing and report generating system for Car Wash

STATISTICS: (money collection, sales, recharges, money change etc..)

PROGRAMS: to have a detailed analysis of the most used or unused programs to define the marketing and sales policies through the PK4

LOGS: detailed control of the operations made by the machine

ALARMS: for example empty dispenser, stop for emergency

LINK TO WEATHER FORECAST: for a major analysis of the roll-over trend



REMOTE
CONTROL



Paymonitoring by Microhard



PayMonitoring è un servizio che rende disponibili report dettagliati di contabilità, vendita e stato di funzionamento di un'intera rete di impianti, agli operatori accreditati tramite accesso Web sulla rete Internet.

FACILE UTILIZZO

I dati vengono trasmessi via ETHERNET e concentrati sul Web server. Ciascun operatore accreditato, tramite accesso Internet e browser per la navigazione, può consultare i report costantemente aggiornati, relativi alla propria rete di impianti, da qualsiasi località.

CARATTERISTICHE

Numero di macchine collegabili: illimitato
Storico disponibile: a partire dall'adesione al servizio

Tipi di dati disponibili

- Incassi
 - dettaglio entrate ed uscite per tipo di moneta e banconota
 - dettaglio importi in base alla causale di utilizzo
 - dettaglio degli importi cashless (acquisto e ricarica)
 - dettaglio incassi di altri dispositivi esterni
- Vendite
 - Dettaglio in base al programma ed alla modalità di pagamento
 - Riepilogo prezzi applicati
 - Dettaglio vendita gettoni e card
- Diagnostica
 - Dettaglio allarmi rilevati
 - Data, ora e tipo dell'allarme

Reportistica

- Livello di dettaglio mensile e giornaliero
- Cifra di incasso netto, o dettaglio voci, per ciascuna macchina
- Somme di riga e colonna presenti in ciascuna videata
- Casella di incasso totale rete nella videata iniziale
- Tasto di generazione grafico su ogni riga
- Funzione di comparazione mese su mese ed anno su anno
- Tasto di esportazione dati disponibile per ogni videata
- Icona meteo su ogni dato, nei report giornalieri



PayMonitoring is a special system generating detailed reports about payments, vends and system status of an entire network of Car Wash plants and making such data available via the Internet (for logged-in operators).

EASY TO USE

Data are transmitted via ETHERNET and stored on Web server. Any operator having a PC equipped with an adequate browser can consult the updated reports of his/her plants from virtually anywhere.

SPECIFICATIONS

No. of machines net-connected: unlimited
History file: data available since the service was started

Data

- Cash Received
 - Money IN and OUT per coin/banknote type
 - Amounts per method of payment
 - Amounts with cashless (purchase and recharge)
 - Cash received originated from other external devices

Vends

- Vends per programme and method of payment
- Summary of prices
- Vends with tokens and cards

Diagnostic

- Alarms detected
- Date/time when alarm was activated and alarm type

Reports

- Monthly and daily details
- Net cash received, or detailed items, for every machine
- Line or column totals in each screen
- Total cash received in the first screen for the entire network
- Graphic-generating button on each line
- Comparison of monthly or yearly results
- Data-exporting button on each screen
- Weather report icon on each item (for daily reports)

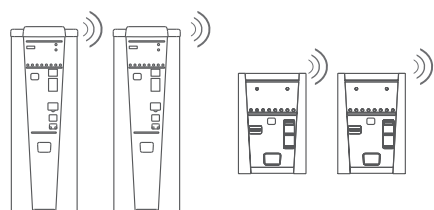

Web Server

Controllo remoto
Paymonitoring

PERIFERICHE

Introduttore di monete antivandalo

- Versione con gettoniera P10

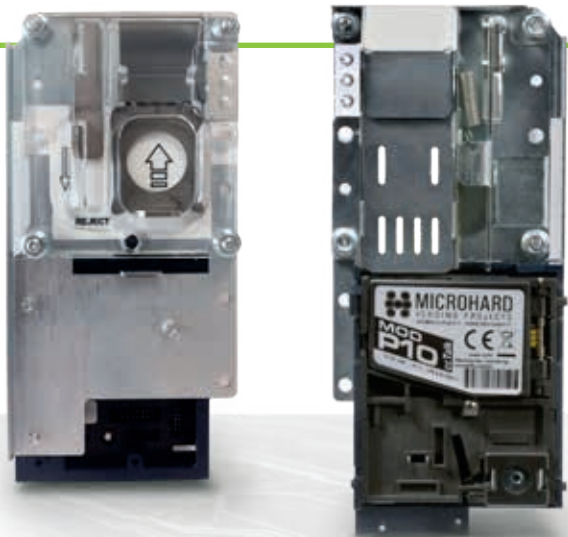

Antivandalo
Vandal proof

Gettoniera elettronica tropicalizzata 4K

- Profilazione automatica delle monete (riferita alla valuta) o gettoni (riferita al modello)
- 4K, il massimo della definizione per una perfetta lettura delle monete/gettoni

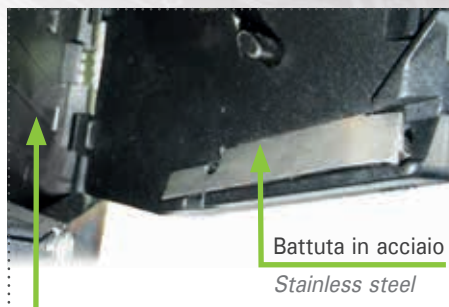

Canale antiaderente
Anti-stick frame

Battuta in acciaio
Stainless steel

Electronica idonea
per esterno
Outdoor suitable
electronics

- Clonazione delle monete: si può programmare una moneta (o l'intero set di monete, o altra valuta) salvarlo in un file e copiarlo su una nuova gettoniera.
- Autocalibrazione dei sensori per una accettazione sempre ottimale nel tempo
- Cloning of coins: you can program a coin (or the all set of coins, or different currency), save it in a file and copy it on a new coin validator.
- Auto-calibration of the sensors for an optimal acceptance over time

PAYMENT SYSTEM

Vandal proof coin insert

- Version with coin selector P10

Tropicalized coin validator 4K

- Automatic Profiling of the coins (referred to the currencies) or tokens (referred to the model)
- 4K, the maximum of the definition for a perfect reading of the coins/token



Sistema antifrode
Anti fraud system



Rinforzo frontalino per ottimizzare il fissaggio
Reinforced front plate for an excellent fixing



Linguetta di salvaguardia cablaggio
Protection system for wiring



DIMENSIONI
DIMENSIONS

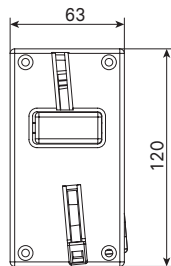
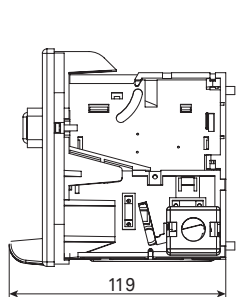
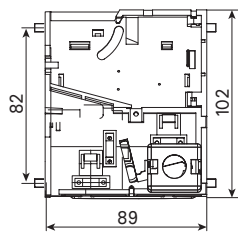

Gettoniera frontalino basso
(per M20)
Low front plate
for Coin Selector

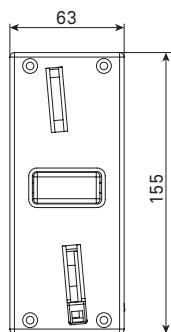
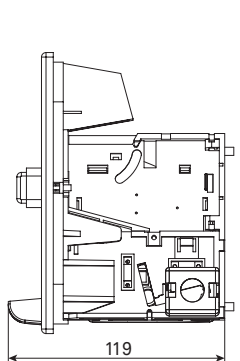

Gettoniera frontalino alto
(per M10 e M20)
High front plate
for Coin Selector
(for M10 and M20)

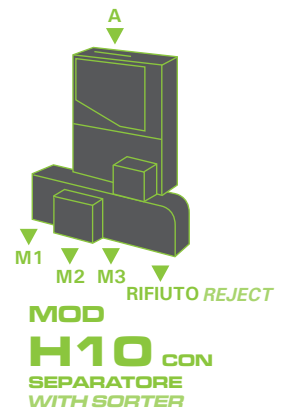
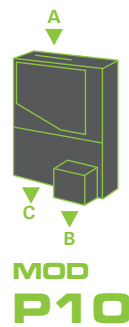
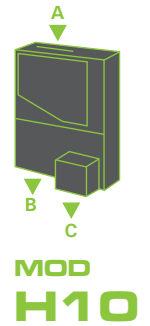
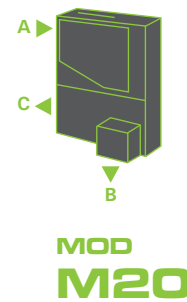
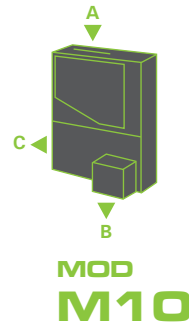

A=INGRESSO MONETA
B=MONETA ACCETTATA
C=MONETA RIFIUTATA

A=ENTRY
B=VALID
C=REJECTED

OPTIONAL

- Cablaggio gettoniera a richiesta
- Coin Selector wire on request



8 - Kit - 01

Kit interfaccia di
configurazione gettoniera
Interface kit to set up the
coin validator

PERIFERICHE

Flexi HOPPER X5™
erogatore monete

FLEXI HOPPER X5 DPO™
MULTIMONETA
(Dynamic Payout)



X5



Maniglia di estrazione
Extraction handle



OPTIONAL: Coperchio con serratura
OPTIONAL: Lockable cover



CARATTERISTICHE

- Erogatore di moneta a cinghia, garanzia di qualità nel tempo per l'erogazione del denaro
- Funzione "agitatore di monete", che evita la creazione di vuoti o ponti di monete
- Disponibilità di serratura supplementare anti estrazione
- Capacità fino a 1500 monete da 1€ o equivalente

FEATURES

- Belt driven coin dispenser ensuring long lasting durability for cash handling
- "Internal Stirrer" function prevents gaps and coins bridging/blockages
- Optional Anti-theft lock available
- Capacity up to n.1500 coins 1€ or equivalent

PAYMENT SYSTEM

Flexi HOPPER X5™
coins/tokens dispenser

FLEXI HOPPER X5 DPO™
MULTICOIN
(Dynamic Payout)

SISTEMI DI PAGAMENTO E ACCESSORI

Diversi metodi pagamento



Sistema di pagamento monete con inseritore antivandalo

Coins Payment system with vandal-proof coin-insert



Letto di banconote con impacchettatore e portellino di protezione a richiesta

Banknotes reader with stacker and security door on request

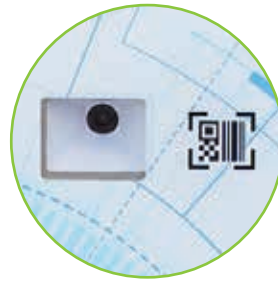

Sistema scanner per QR Code

Scanner System for QR Codes



Sistema POS per lettura carta di credito a bancomat

POS System for credit cards reading



Fidelizzazione della clientela tramite sistema di pagamento cashless a Card e Tag

Customer loyalty through Card or cashless payment system



Distributore di fidelity card

Fidelity card dispenser



Stampante termica per ricevuta non fiscale

Printer for non-fiscal receipt



Pulsanti antivandalo Test, Reset, Stop

Vandal-proof buttons Test, Reset, Stop

PAYMENT SOLUTIONS AND ACCESSORIES

Different payment methods

ASSISTENZA

La mission aziendale di Microhard è la soddisfazione totale del cliente, per questa ragione ha molto a cuore anche il post-vendita. In ogni paese in cui opera, Microhard può garantire:

- assistenza sui prodotti
- corsi tecnici/commerciali ai partner
- meeting di aggiornamento
- eventi istituzionali

“SMART” ALWAYS WITH U

Sistema esclusivo di assistenza Smart Always With U (WhatsApp BOT- Canale YouTube con tutorial - Live Chat raggiungibile dal sito)



App MyMicrohard

L' App per metterti in contatto con l'assistenza, con gli operatori e con le tue macchine direttamente dallo smartphone.



ASSISTANCE

The Microhard company target is the total customer satisfaction and for this reason the company cares a lot the post- sale. In each country where the company is present, it can grant:

- post sale assistance on its products
- tech training / trade partners
- meeting of updating
- istitutitional events

“SMART” ALWAYS WITH U

Exclusive assistance system Smart Always With U (WhatsApp BOT - YouTube Channel with tutorial - Live Chat accessible from the website)

App MyMicrohard

The App allows to connect with our assistance network, with our operators and allows to get in contact with all the machines by the smartphone.



PERSONALIZZAZIONI CUSTOMIZATION

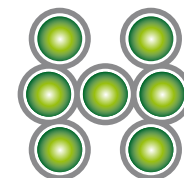

MICROHARD[®]
VENDING PROJECTS



Non è solamente il principio del “buon lavoro” a muovere l’entusiasmo dello staff Microhard, ma anche una passione smisurata per ciò che viene realizzato quotidianamente. L’esigenza di soddisfare ed entusiasmare i propri clienti, da sempre considerati partner di lavoro è, tra tutti, uno dei dogmi principali di Microhard.

It is not only the principle of “good workmanship” that fuels the enthusiasm of Microhard’s staff, but also a boundless passion for the everyday activities they perform. The need to satisfy and arouse customers, always treated as partners, is one of the main dogmas of Microhard.



CATALOGO - CATALOGUE

Rev. 12/22

SOLUZIONI PER AUTOLAVAGGI CARWASH SOLUTIONS

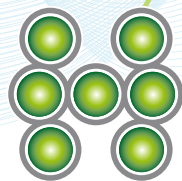

MICROHARD[®]
VENDING PROJECTS

Microhard[®] s.r.l.

Sede operativa 1: Via F.lli Rosselli, 14/B - 40069 Zola Predosa (BO) ITALY
Tel.: +39 051 58.72.037 - Fax +39 051 58.72.028

Sede operativa 2: Via dei Platani, 7 - 47042 CESENATICO (FC) ITALY
Tel.: +39 (0547) 75450 - Fax: +39 (0547) 81247

Sede legale: Via Santo Stefano 11 - 40125 Bologna
info@microhard.it - www.microhard.it